

1 TYPICAL "SELECT" PERFORATED RAILING SYSTEM  
AI SCALE: 1"=1'-0"

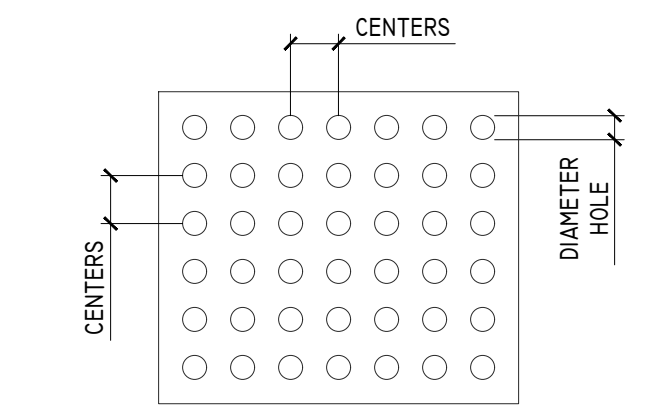

2 STANDARD ROUND HOLES  
AI SCALE: 3"=1'-0"

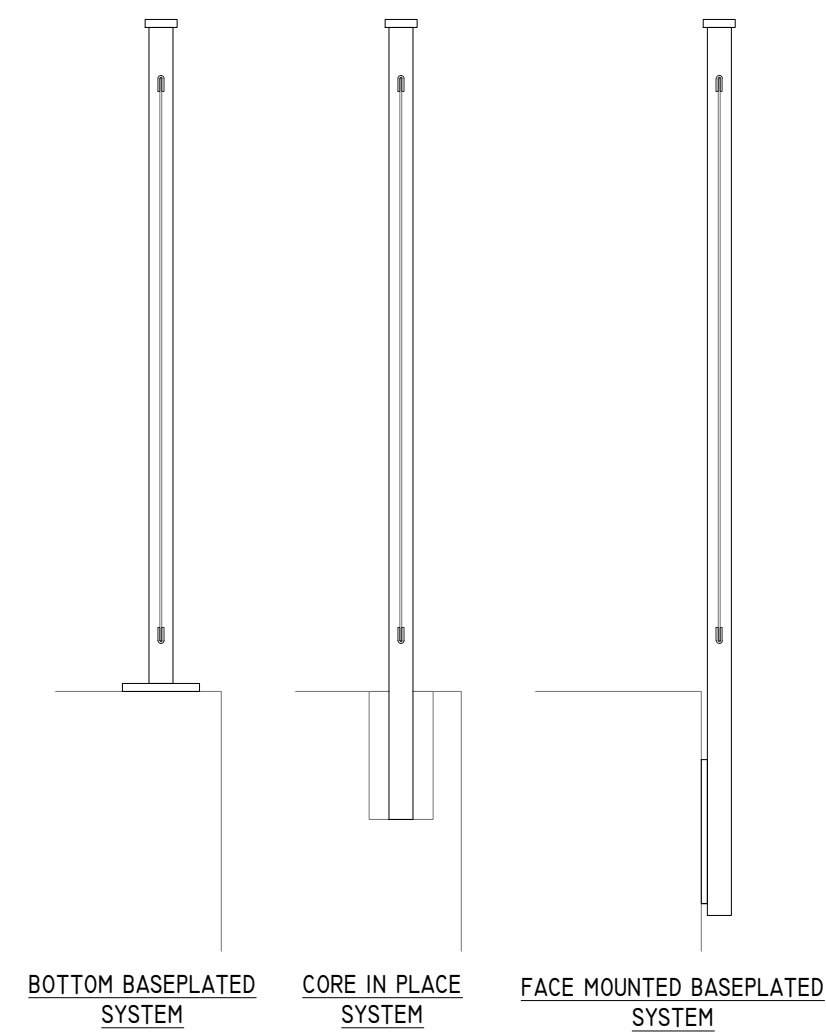
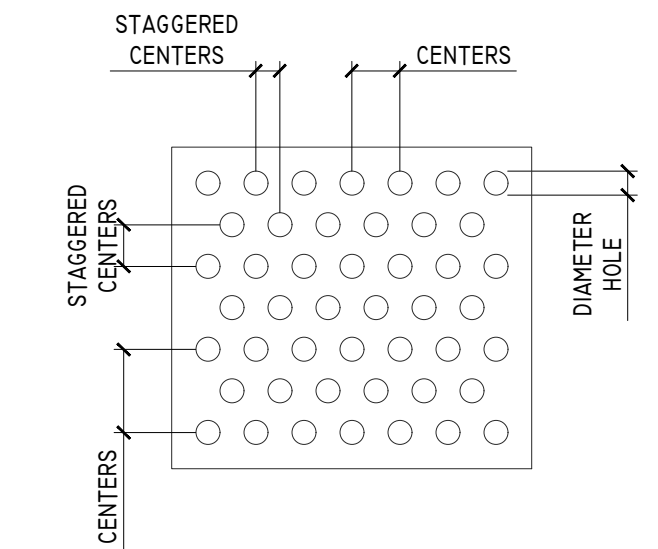

3 STAGGERED ROUND HOLES  
AI SCALE: 3"=1'-0"

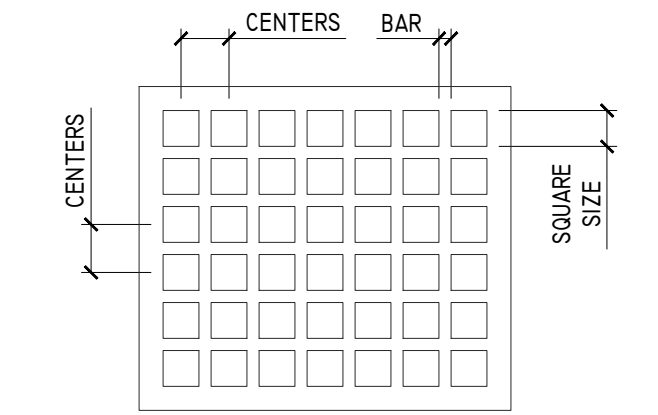

4 STANDARD SQUARE HOLES  
AI SCALE: 3"=1'-0"

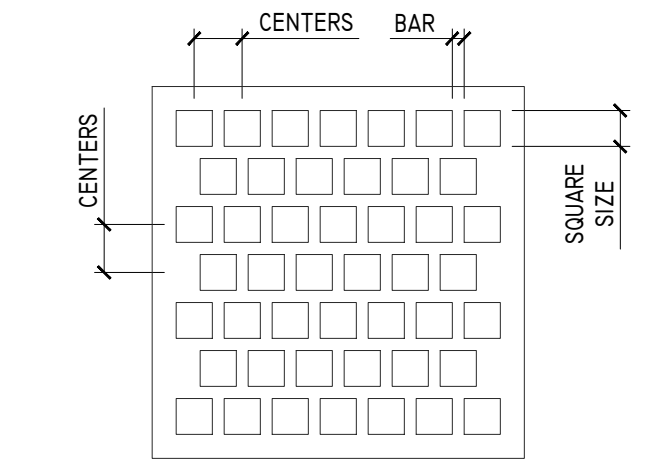

5 STAGGERED SQUARE HOLES  
AI SCALE: 3"=1'-0"

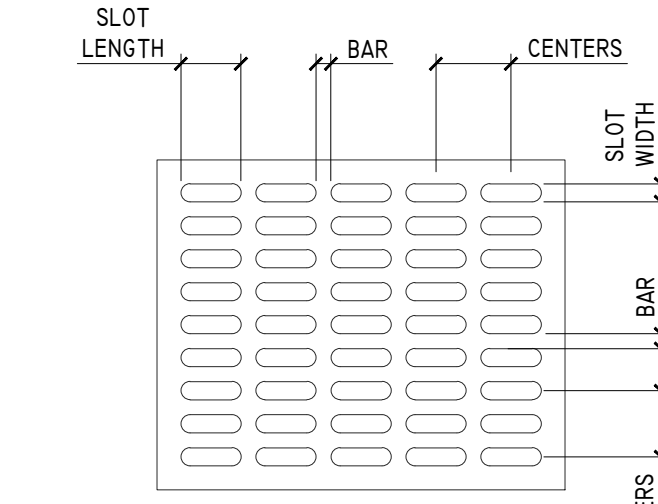

6 STANDARD SLOTTED HOLES  
AI SCALE: 3"=1'-0"

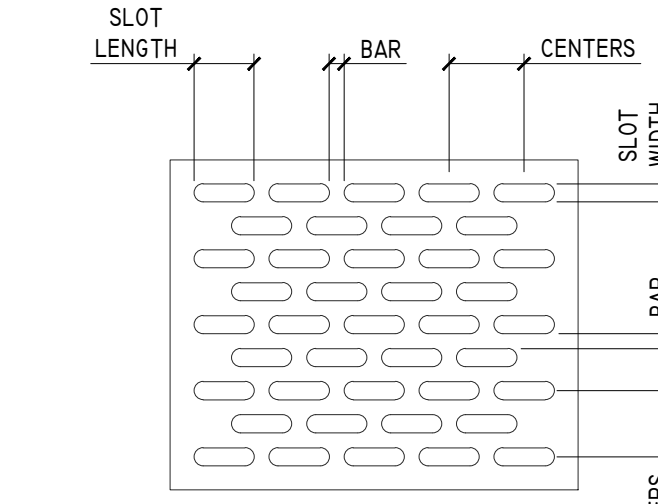

7 STAGGERED SLOTTED HOLES  
AI SCALE: 3"=1'-0"

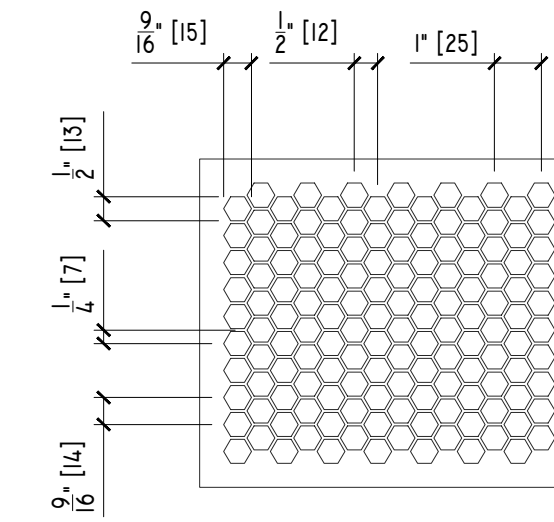

8 HEXAGONAL DECORATIVE  
AI SCALE: 3"=1'-0"

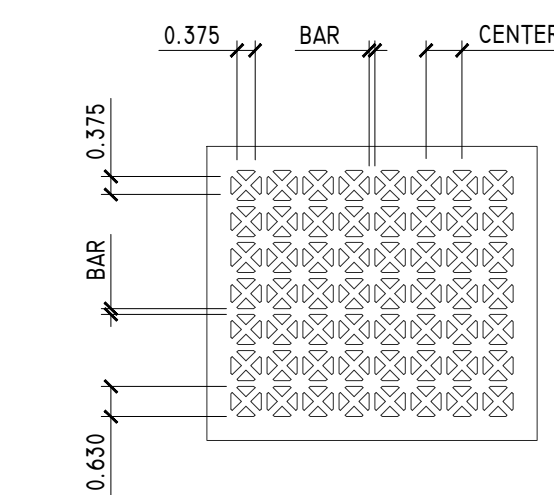

9 GRECIAN DECORATIVE  
AI SCALE: 3"=1'-0"

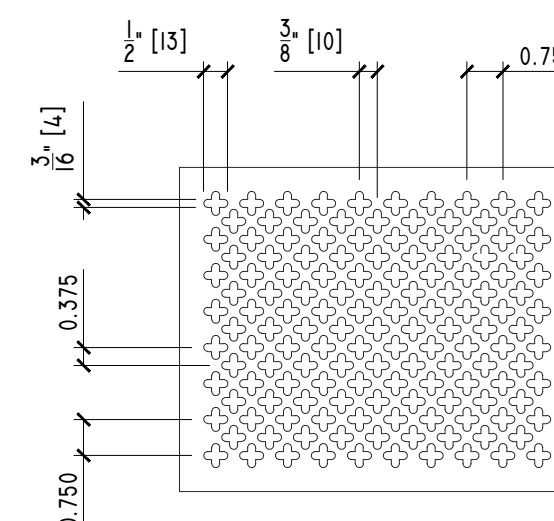

10 FULL CLOVERLEAF DECORATIVE  
AI SCALE: 3"=1'-0"

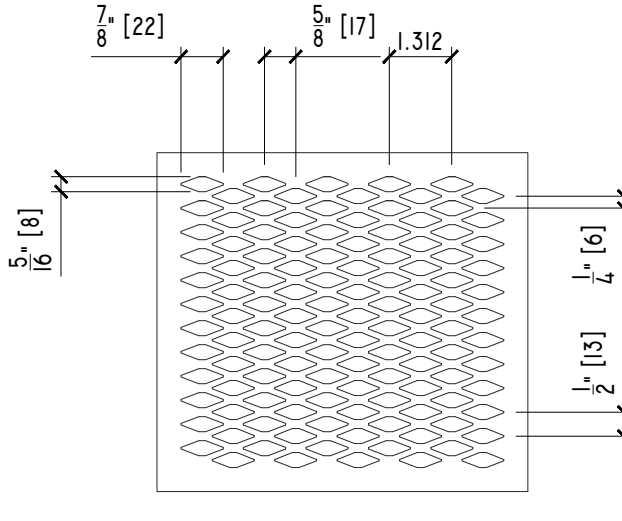

11 DIAMOND STAGGERED DECORATIVE  
AI SCALE: 3"=1'-0"

THIS DRAWING IN DESIGN AND DETAIL IS THE SOLE PROPERTY OF MFR MANUFACTURING CORPORATION, INC. AND MAY NOT BE USED FOR ANY PURPOSE WHATSOEVER OTHER THAN FOR OUR MANUFACTURING FACILITY AND INSTALLATION OF OUR PRODUCTS. THIS DOCUMENT OR ANY PART THEREOF MAY NOT BE REPRODUCED IN ANY MANNER WHATSOEVER AND SHALL BE RETURNED TO US UPON REQUEST. ALL RIGHTS RESERVED.

| REV. NO. | REV. DATE | REVISED ITEMS | REV. BY |
|----------|-----------|---------------|---------|
|          |           |               |         |
|          |           |               |         |
|          |           |               |         |
|          |           |               |         |

CONTENTS:  
"SELECT" PERFORATED RAILING INFILL PANEL DETAILS

**METALCO**  
MFR MANUFACTURING CORP.  
1065 SILL AVE. AURORA IL 60506  
(815) 552-3333  
WWW.MFRCORP.COM

PROJECT: "SELECT" PERFORATED RAILING SYSTEM  
ADDRESS:  

DRAWN BY: GM  
CHECKED BY: KM

SCALE: AS NOTED  
DATE: 3/3/2021

JOB NO. S-PERF

SHEET NO. AI